

1 TOWNSEND AND TOWNSEND AND CREW LLP  
GREGORY S. GILCHRIST (Bar # 111536)  
2 GIA L. CINCONI (Bar # 141668)  
Two Embarcadero Center, 8th Floor  
3 San Francisco, California 94111  
Telephone: (415) 576-0200  
4 Facsimile: (415) 576-0300  
Email: gsgilchrist@townsend.com, glcincone@townsend.com

5 Attorneys for Plaintiff  
6 LEVI STRAUSS & CO.

**ORIGINAL  
FILED**

**JUL 20 2007**

**RICHARD W. WIEKING  
CLERK, U.S. DISTRICT COURT  
NORTHERN DISTRICT OF CALIFORNIA**

**E-Filing**

8 UNITED STATES DISTRICT COURT

**PVT**

9 FOR THE NORTHERN DISTRICT OF CALIFORNIA

10  
11 LEVI STRAUSS & CO.,

12 Plaintiff,

13 v.

14 ABERCROMBIE & FITCH TRADING CO.,

15 Defendant.

**Case No. C 07 3752**

**COMPLAINT FOR TRADEMARK  
INFRINGEMENT, UNFAIR  
COMPETITION AND DILUTION  
(INJUNCTIVE RELIEF SOUGHT)**

**JURY TRIAL DEMAND**

16  
17 Plaintiff Levi Strauss & Co. ("LS&CO.") complains against defendant Abercrombie & Fitch  
18 Trading Co. ("A&F") as follows:

19 **JURISDICTION, VENUE AND INTRA-DISTRICT ASSIGNMENT**

20 1. Plaintiff's first, second and third claims arise under the Trademark Act of 1946 (the  
21 Lanham Act), as amended by the Federal Trademark Dilution Act of 1995 (15 U.S.C. §§ 1051, et  
22 seq.). This Court has jurisdiction over such claims pursuant to 28 U.S.C. §§ 1338(a) and 1338(b)  
23 (trademark and unfair competition), 28 U.S.C. § 1331 (federal question) and 15 U.S.C. § 1121  
24 (Lanham Act). This Court has supplemental jurisdiction over the remaining state law claims under 28  
25 U.S.C. § 1367.

26 2. LS&CO. is informed and believes that venue is proper in this Court under 28 U.S.C. §  
27 1391(b) because Defendant transacts affairs in this district and because a substantial part of the events  
28 giving rise to the claims asserted arose in this district.



1 **LS&CO.'s Arcuate Stitching Design Trademark**

2 8. Among its marks, LS&CO. owns the famous Arcuate Stitching Design Trademark (the  
3 "Arcuate trademark"), which consists of a distinctive pocket stitching design that is the oldest known  
4 apparel trademark in the United States. LS&CO. has used the Arcuate trademark continuously since  
5 1873 in interstate commerce on clothing products. LS&CO. first used the Arcuate trademark on jeans  
6 and later used it on trousers, pants, shorts, skirts, shirts and jackets. Examples of LS&CO.'s use of the  
7 Arcuate trademark on LEVI'S® jeans are attached as Exhibit A.

8 9. LS&CO. owns, among others, the following United States and California Registrations  
9 for its Arcuate trademark, attached as Exhibit B:

10 a. U.S. Registration No. 404,248 (first used as early as 1873; registered November  
11 16, 1943).

12 b. U.S. Registration No. 1,139,254 (first used as early as 1873; registered  
13 September 2, 1980);

14 These registrations have become incontestable under the provisions of 15 U.S.C. § 1065.

15 c. U.S. Registration No. 2,791,156 (first used as early as September 1, 1936;  
16 registered December 9, 2003)

17 d. U.S. Registration No. 2,794,649 (first used as early as 1873; registered  
18 December 16, 2003.)

19 e. California Registration No. 088399 (first used as early as 1873; registered  
20 August 24, 1988).

21 10. The Arcuate trademark is famous and is recognized around the world and throughout  
22 the United States by consumers as signifying a high quality LEVI'S® product.

23 **A&F's Infringement of LS&CO.'s Arcuate Trademark**

24 11. LS&CO. is informed and believes that A&F has in the past and continues to  
25 manufacture, source, market and/or sell clothing that displays stitching designs that are confusingly  
26 similar to LS&CO.'s Arcuate trademark, including but not limited to RUEHL brand jeans bearing the  
27 design shown in Exhibit C (the "A&F stitching design").

28 12. A&F has filed trademark applications with the United States Patent and Trademark

1 Office ("PTO") to register the A&F stitching design (Serial Numbers 78/766,368 and 78/977,782).  
2 Both applications are currently pending with the PTO; one of the applications (Serial Number  
3 78/766,368) has been published for opposition and LS&CO. has filed a Notice of Opposition to  
4 registration of the proposed mark.

5 13. LS&CO. is informed and believes that A&F has manufactured, marketed and sold  
6 substantial quantities of products bearing the A&F stitching design, and has obtained and continues to  
7 obtain substantial profits thereby.

8 14. A&F's actions as alleged herein have caused and will cause LS&CO. irreparable harm  
9 for which money damages and other remedies are inadequate. Unless A&F is restrained by this Court,  
10 it will continue and/or expand the illegal activities alleged in this Complaint and otherwise continue to  
11 cause great and irreparable damage and injury to LS&CO. by, among other things:

- 12 a. Depriving LS&CO. of its statutory rights to use and control use of its  
13 trademark;
- 14 b. Creating a likelihood of confusion, mistake and deception among consumers  
15 and the trade as to the source of the infringing products;
- 16 c. Causing the public falsely to associate LS&CO. with A&F and/or its products,  
17 or vice versa;
- 18 d. Causing incalculable and irreparable damage to LS&CO.'s goodwill and  
19 diluting the capacity of its Arcuate trademark to differentiate LEVI'S® products  
20 from others; and
- 21 e. Causing LS&CO. to lose sales of its genuine clothing products.

22 15. Accordingly, in addition to other relief sought, LS&CO. is entitled to preliminary and  
23 permanent injunctive relief against A&F and all persons acting in concert with it.

24 **FIRST CLAIM**  
25 **FEDERAL TRADEMARK INFRINGEMENT**  
26 **(15 U.S.C. §§ 1114-1117; Lanham Act § 32)**

27 16. LS&CO. realleges and incorporates by reference each of the allegations contained in  
28 paragraphs 1 through 15 of this Complaint.

1 17. Without LS&CO.'s consent, A&F has used, in connection with the sale, offering for  
2 sale, distribution or advertising of its products, designs that infringe upon LS&CO.'s registered  
3 Arcuate trademark.

4 18. These acts of trademark infringement have been committed with the intent to cause  
5 confusion, mistake, or deception, and are in violation of 15 U.S.C. § 1114.

6 19. As a direct and proximate result of A&F's infringing activities, LS&CO. has suffered  
7 substantial damage.

8 20. A&F's infringement of LS&CO.'s trademark as alleged herein is an exceptional case  
9 and was intentional, entitling LS&CO. to treble its actual damages and to an award of attorneys' fees  
10 under 15 U.S.C. §§ 1117(a) and 1117(b).

11 **SECOND CLAIM**  
12 **FEDERAL UNFAIR COMPETITION**  
13 **(False Designation of Origin and False Description)**  
14 **(15 U.S.C. § 1125(a); Lanham Act § 43(a))**

15 21. LS&CO. realleges and incorporates by reference each of the allegations contained in  
16 paragraphs 1 through 20 of this Complaint.

17 22. A&F's conduct constitutes the use of symbols or devices tending falsely to describe the  
18 infringing products, within the meaning of 15 U.S.C. § 1125(a)(1). A&F's conduct is likely to cause  
19 confusion, mistake, or deception by or in the public as to the affiliation, connection, association,  
20 origin, sponsorship or approval of the infringing products to the detriment of LS&CO. and in violation  
21 of 15 U.S.C. § 1125(a)(1).

22 23. As a direct and proximate result of A&F's infringing activities, LS&CO. has suffered  
23 substantial damage.

24 **THIRD CLAIM**  
25 **FEDERAL DILUTION OF FAMOUS MARK**  
26 **(Federal Trademark Dilution Act of 1995)**  
27 **(15 U.S.C. § 1125(c); Lanham Act § 43(c))**

28 24. LS&CO. realleges and incorporates by reference each of the allegations contained in  
29 paragraphs 1 through 23 of this Complaint.

30 25. LS&CO.'s Arcuate trademark is distinctive and famous within the meaning of the

1 Federal Trademark Dilution Act of 1995, 15 U.S.C. § 1125(c), as amended.

2 26. A&F's activities as alleged herein, both separately and collectively, have diluted or are  
3 likely to dilute the distinctive quality of LS&CO.'s trademark in violation of the Federal Trademark  
4 Dilution Act of 1995, 15 U.S.C. § 1125(c), as amended.

5 27. LS&CO. is entitled to injunctive relief pursuant to 15 U.S.C. § 1125(c).

6 28. Because A&F willfully intended to trade on LS&CO.'s reputation and/or to cause  
7 dilution of LS&CO.'s famous trademark, LS&CO. is entitled to damages, extraordinary damages, fees  
8 and costs pursuant to 15 U.S.C. § 1125(c)(2).

9 **FOURTH CLAIM**  
10 **CALIFORNIA DILUTION AND TRADEMARK INFRINGEMENT**  
11 **(Cal. Bus. & Prof. Code §§ 14320, 14330, 14335, 14340)**

12 29. LS&CO. realleges and incorporates by reference each of the allegations contained in  
13 paragraphs 1 through 28 of this Complaint.

14 30. A&F's infringement of LS&CO.'s federal and state registered trademark is likely to  
15 cause consumer confusion and dilution of LS&CO.'s trademark in violation of California Business &  
16 Professions Code Sections 14320, 14330, and 14335.

17 31. A&F infringed and diluted LS&CO.'s Arcuate trademark with knowledge and intent to  
18 cause confusion, mistake or deception.

19 32. A&F's conduct is aggravated by that kind of willfulness, wantonness, malice and  
20 conscious indifference to the rights and welfare of LS&CO. for which California law allows the  
21 imposition of exemplary damages.

22 33. Pursuant to California Business & Professions Code § 14340, LS&CO. is entitled to  
23 injunctive relief and damages in the amount of three times A&F's profits and three times all damages  
24 suffered by LS&CO. by reason of A&F's manufacture, use, display or sale of infringing goods.

25 **FIFTH CLAIM**  
26 **CALIFORNIA UNFAIR COMPETITION**  
27 **(Cal. Bus. & Prof. Code § 17200)**

28 34. LS&CO. realleges and incorporates by reference each of the allegations contained in  
29 paragraphs 1 through 33 of this Complaint.

30 35. A&F's infringement of LS&CO.'s Arcuate trademark constitutes "unlawful, unfair or

1 fraudulent business act[s] or practice[s] and unfair, deceptive, untrue or misleading advertising" within  
2 the meaning of California Business & Professions Code Section 17200.

3 36. As a consequence of A&F's actions, LS&CO. is entitled to injunctive relief and an  
4 order that A&F disgorge all profits on the manufacture, use, display or sale of infringing goods.

5 **PRAYER FOR JUDGMENT**

6 WHEREFORE, LS&CO. prays that this Court grant it the following relief:

7 37. Adjudge that LS&CO.'s Arcuate trademark has been infringed by A&F in violation of  
8 LS&CO.'s rights under common law, 15 U.S.C. § 1114, and/or California law;

9 38. Adjudge that A&F has competed unfairly with LS&CO. in violation of LS&CO.'s  
10 rights under common law, 15 U.S.C. § 1125(a), and/or California law;

11 39. Adjudge that A&F's activities are likely to, or have, diluted LS&CO.'s famous Arcuate  
12 trademark in violation of LS&CO.'s rights under common law, 15 U.S.C. § 1125(c), and/or California  
13 law;

14 40. Adjudge that A&F and its agents, employees, attorneys, successors, assigns, affiliates,  
15 and joint venturers and any person(s) in active concert or participation with it, and/or any person(s)  
16 acting for, with, by, through or under it, be enjoined and restrained at first during the pendency of this  
17 action and thereafter permanently from:

18 a. Manufacturing, producing, sourcing, importing, selling, offering for sale,  
19 distributing, advertising, or promoting any goods that display any words or symbols that so resemble  
20 LS&CO.'s Arcuate trademark as to be likely to cause confusion, mistake or deception, on or in  
21 connection with any product that is not authorized by or for LS&CO., including without limitation any  
22 product that bears the A&F stitching design which is the subject of this Complaint and for which A&F  
23 is responsible, or any other approximation of LS&CO.'s Arcuate trademark;

24 b. Using any word, term, name, symbol, device or combination thereof that causes  
25 or is likely to cause confusion, mistake or deception as to the affiliation or association of A&F or its  
26 products with LS&CO. or as to the origin of A&F's goods, or any false designation of origin, false or  
27 misleading description or representation of fact;

28 c. Further infringing the rights of LS&CO. in and to any of its trademarks in its

1 LEVI'S® brand products or otherwise damaging LS&CO.'s goodwill or business reputation;

2 d. Otherwise competing unfairly with LS&CO. in any manner; and

3 e. Continuing to perform in any manner whatsoever any of the other acts

4 complained of in this Complaint;

5 41. Adjudge that A&F be required immediately to supply LS&CO.'s counsel with a  
6 complete list of individuals and entities from whom or which it purchased, and to whom or which it  
7 sold, offered for sale, distributed, advertised or promoted, infringing products as alleged in this  
8 Complaint;

9 42. Adjudge that A&F be required immediately to deliver to LS&CO.'s counsel its entire  
10 inventory of infringing products, including without limitation pants and any other clothing, packaging,  
11 labeling, advertising and promotional material and all plates, patterns, molds, matrices and other  
12 material for producing or printing such items, that are in its possession or subject to its control and that  
13 infringe LS&CO.'s Arcuate trademark as alleged in this Complaint;

14 43. Adjudge that A&F, within thirty (30) days after service of the judgment demanded  
15 herein, be required to file with this Court and serve upon LS&CO.'s counsel a written report under  
16 oath setting forth in detail the manner in which it has complied with the judgment;

17 44. Adjudge that LS&CO. recover from A&F its damages and lost profits in an amount to  
18 be proven at trial;

19 45. Adjudge that A&F be required to account for any profits that are attributable to its  
20 illegal acts, and that LS&CO. be awarded the greater of (1) three times A&F's profits or (2) three  
21 times any damages sustained by LS&CO., under 15 U.S.C. § 1117, plus prejudgment interest;

22 46. Order an accounting of and impose a constructive trust on all of A&F's funds and  
23 assets that arise out of his infringing activities;

24 47. Direct the PTO to refuse registration to Trademark Application Serial Numbers  
25 78/766,368 and 78/977,782

26 48. Adjudge that LS&CO. be awarded its costs and disbursements incurred in connection  
27 with this action, including LS&CO.'s reasonable attorneys' fees and investigative expenses; and  
28



1  
2  
3  
4  
5  
6  
7  
8  
9  
10  
11  
12  
13  
14  
15  
16  
17  
18  
19  
20  
21  
22  
23  
24  
25  
26  
27  
28

49. Adjudge that all such other relief be awarded to LS&CO. as this Court deems just and proper.

DATED: July 20, 2007

Respectfully submitted,

By:   
Gia L. Cincone  
TOWNSEND AND TOWNSEND AND CREW LLP  
Two Embarcadero Center, Eighth Floor  
San Francisco, California 94111  
Telephone: (415) 576-0200  
Facsimile: (415) 576-0300

Attorneys for Plaintiff  
LEVI STRAUSS & CO.

**DEMAND FOR JURY TRIAL**

LS&CO. demands that this action be tried to a jury.

DATED: July 20, 2007

Respectfully submitted,

By:   
Gia L. Cincone  
TOWNSEND AND TOWNSEND AND CREW LLP  
Two Embarcadero Center, Eighth Floor  
San Francisco, California 94111  
Telephone: (415) 576-0200  
Facsimile: (415) 576-0300

Attorneys for Plaintiff  
LEVI STRAUSS & CO.

1  
2  
3  
4  
5  
6  
7  
8  
9  
10  
11  
12  
13  
14  
15  
16  
17  
18  
19  
20  
21  
22  
23  
24  
25  
26  
27  
28

## Exhibit A



Exhibit A-1



Exhibit A-2



Exhibit A-3



Exhibit A-4



Exhibit A-5





Exhibit A-6

## Exhibit B



428326



**THE UNITED STATES OF AMERICA**

**TO ALL TO WHOM THESE PRESENTS SHALL COME:  
UNITED STATES DEPARTMENT OF COMMERCE**

**United States Patent and Trademark Office**

July 16, 2001

THE ATTACHED U.S. TRADEMARK REGISTRATION 404,248 IS  
CERTIFIED TO BE A TRUE COPY WHICH IS IN FULL FORCE AND  
EFFECT WITH NOTATIONS OF ALL STATUTORY ACTIONS TAKEN  
THEREON AS DISCLOSED BY THE RECORDS OF THE UNITED STATES  
PATENT AND TRADEMARK OFFICE.

REGISTERED FOR A TERM OF 20 YEARS FROM *November 16, 1943*  
2nd RENEWAL FOR A TERM OF 20 YEARS FROM *November 16, 1983*  
SECTION 8 & 15

REPUBLISHED SECTION 12C

SAID RECORDS SHOW TITLE TO BE IN:

*STRAUSS, LEVI & CO.*



By Authority of the  
**COMMISSIONER OF PATENTS AND TRADEMARKS**

*H. Phillips*  
**H. PHILLIPS**  
Certifying Officer

Registered Nov. 16, 1943

Trade-Mark 404,248

Republished, under the Act of 1946, April 27, 1948, by  
Levi Strauss & Company, San Francisco, Calif.

Affidavit under Section 8 accepted.

Affidavit under Section 15 received, Aug. 31, 1953.

## UNITED STATES PATENT OFFICE

Levi Strauss & Company, San Francisco, Calif.

Act of February 20, 1905

Application September 25, 1942, Serial No. 455,769

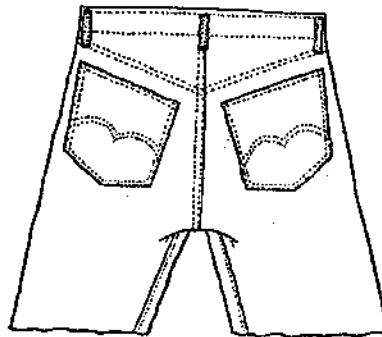

### STATEMENT

*To the Commissioner of Patents:*

Levi Strauss & Company, a corporation duly organized under the laws of the State of California and located at the city and county of San Francisco, State of California, and doing business at 98 Battery Street, San Francisco, California, has adopted and used the trade-mark shown in the accompanying drawing, for WAISTBAND TYPE OVERALLS, in Class 39, Clothing, and presents herewith five facsimiles showing the trade-mark as actually used by applicant upon the goods, and requests that the same be registered in the United States Patent Office in accordance with act of February 20, 1905. The trade-mark has been continuously used and applied to said goods in applicant's business since the year 1873. The trade-mark consists of double arcuate designs of orange color displayed on the hip pockets of the overalls as shown on the drawing. The mark is applied to the overalls

by stitching the double arcuate designs on the hip pockets with orange colored thread, or by painting the lines of said design on the hip pockets with orange colored paint.

No claim is made to the exclusive use of the representation of a pair of overalls.

The undersigned hereby appoints Castberg & Roemer, a firm composed of Thomas Castberg and Irving C. Roemer, whose address is 807 Crocker Building, San Francisco, California, and whose registration number is 15,030, as its attorneys, with full power of substitution and revocation, to prosecute this application, to make alterations and amendments therein, to receive the certificate of registration, and to transact all business in the Patent Office connected therewith.

LEVI STRAUSS & COMPANY,  
By DANIEL E. KOSHLAND,  
Vice President.

438326

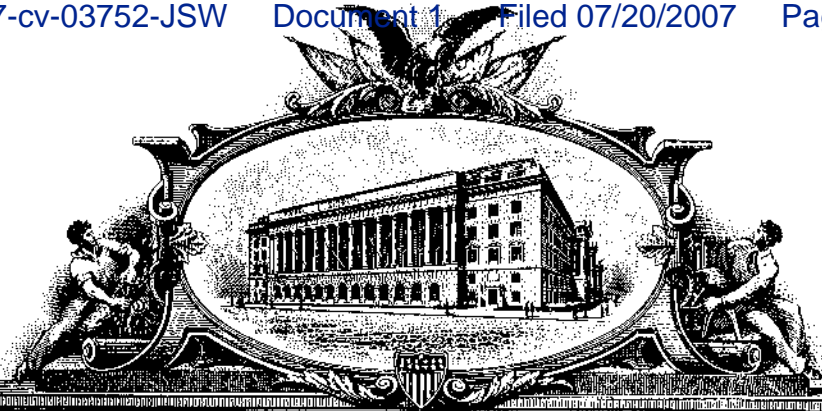

# THE UNITED STATES OF AMERICA

**TO ALL TO WHOM THESE PRESENTS SHALL COME:**

**UNITED STATES DEPARTMENT OF COMMERCE**

**United States Patent and Trademark Office**

**July 16, 2001**

**THE ATTACHED U.S. TRADEMARK REGISTRATION 1,139,254 IS CERTIFIED TO BE A TRUE COPY WHICH IS IN FULL FORCE AND EFFECT WITH NOTATIONS OF ALL STATUTORY ACTIONS TAKEN THEREON AS DISCLOSED BY THE RECORDS OF THE UNITED STATES PATENT AND TRADEMARK OFFICE.**

**REGISTERED FOR A TERM OF 20 YEARS FROM *September 02, 1980***

**SECTION 8 & 15**

**SAID RECORDS SHOW TITLE TO BE IN:**

***LEVI STRAUSS & CO.***

***A DE CORP***



**By Authority of the  
COMMISSIONER OF PATENTS AND TRADEMARKS**

*H. Phillips*  
**H. PHILLIPS**  
Certifying Officer

**Int. Cl.: 25**

**Prior U.S. Cl.: 39**

**Reg. No. 1,139,254**

**United States Patent and Trademark Office**

**Registered Sep. 2, 1980**

**TRADEMARK**

**Principal Register**

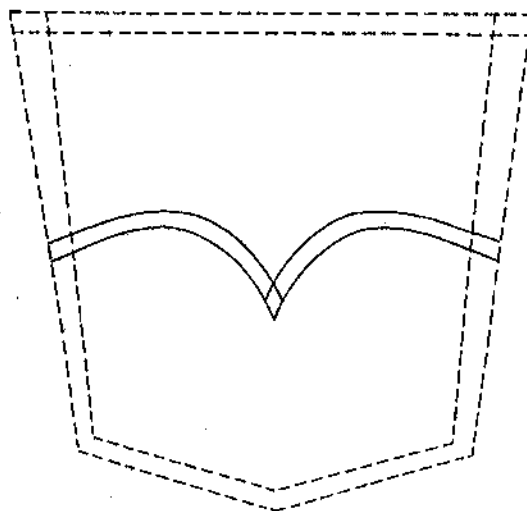

Levi Strauss & Co. (Delaware corporation)  
Two Embarcadero Ctr.  
San Francisco, Calif. 94106

For: PANTS, JACKETS, SKIRTS, DRESSES AND  
SHORTS, in CLASS 25 (U.S. CL. 39).  
First use 1873; in commerce 1873.  
Owner of U.S. Reg. No. 404,248.

Ser. No. 169,399. Filed May 8, 1978.

M. J. LEAHY, Primary Examiner



UNITED STATES DEPARTMENT OF COMMERCE  
Patent and Trademark Office  
OFFICE OF ASSISTANT COMMISSIONER FOR TRADEMARKS  
2900 Crystal Drive  
Arlington, Virginia 22202-3513

REGISTRATION NO: 1139254 SERIAL NO: 73169399 MAILING DATE: 08/06/2001  
REGISTRATION DATE: 09/02/1980  
MARK: MISCELLANEOUS DESIGN  
REGISTRATION OWNER: LEVI STRAUSS & CO.  
CORRESPONDENCE ADDRESS:

SARAH R. FULLER  
LEGAL STRATEGIES GROUP  
5905 CHRISTIE AVENUE  
EMERYVILLE, CA 94608-1925

### NOTICE OF ACCEPTANCE

15 U.S.C. Sec. 1058(a)(3)

THE COMBINED AFFIDAVIT AND RENEWAL APPLICATION FILED FOR THE ABOVE-IDENTIFIED REGISTRATION MEETS THE REQUIREMENTS OF SECTION 8 OF THE TRADEMARK ACT, 15 U.S.C. Sec. 1058.

ACCORDINGLY, THE SECTION 8 AFFIDAVIT IS ACCEPTED.

\*\*\*\*\*

### NOTICE OF RENEWAL

15 U.S.C. Sec. 1059(a)

THE COMBINED AFFIDAVIT AND RENEWAL APPLICATION FILED FOR THE ABOVE-IDENTIFIED REGISTRATION MEETS THE REQUIREMENTS OF SECTION 9 OF THE TRADEMARK ACT, 15 U.S.C. Sec. 1058.

ACCORDINGLY, THE REGISTRATION IS RENEWED.

\*\*\*\*\*

THE REGISTRATION WILL REMAIN IN FORCE FOR CLASS(ES):  
025.

HARPER, BARBARA A  
PARALEGAL SPECIALIST  
POST-REGISTRATION DIVISION  
(703)308-9500

PLEASE SEE THE REVERSE SIDE OF THIS NOTICE FOR INFORMATION CONCERNING REQUIREMENTS FOR MAINTAINING THIS REGISTRATION

7006650

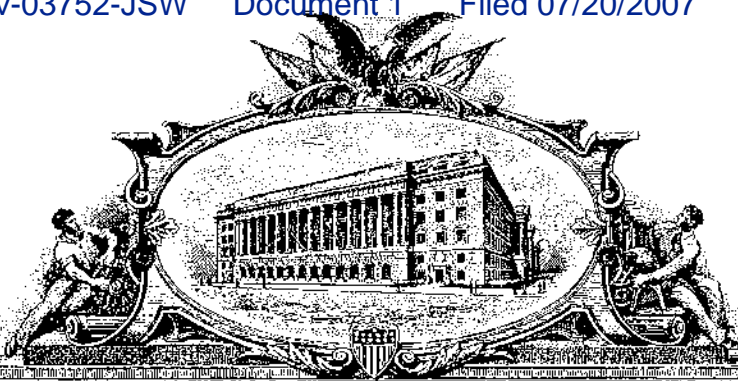

**THE UNITED STATES OF AMERICA**

**TO ALL TO WHOM THESE PRESENTS SHALL COME:**

**UNITED STATES DEPARTMENT OF COMMERCE**

United States Patent and Trademark Office

April 06, 2006

THE ATTACHED U.S. TRADEMARK REGISTRATION 2,791,156 IS CERTIFIED TO BE A TRUE COPY WHICH IS IN FULL FORCE AND EFFECT WITH NOTATIONS OF ALL STATUTORY ACTIONS TAKEN THEREON AS DISCLOSED BY THE RECORDS OF THE UNITED STATES PATENT AND TRADEMARK OFFICE.

REGISTERED FOR A TERM OF 10 YEARS FROM *December 09, 2003*

SAID RECORDS SHOW TITLE TO BE IN:

*LEVI STRAUSS & CO.*

*A DELAWARE CORPORATION*

By Authority of the  
Under Secretary of Commerce for Intellectual Property  
and Director of the United States Patent and Trademark Office

L. EDELEN  
Certifying Officer





Int. Cl.: 25

Prior U.S. Cls.: 22 and 39

**United States Patent and Trademark Office**

Reg. No. 2,791,156

Registered Dec. 9, 2003

**TRADEMARK  
PRINCIPAL REGISTER**

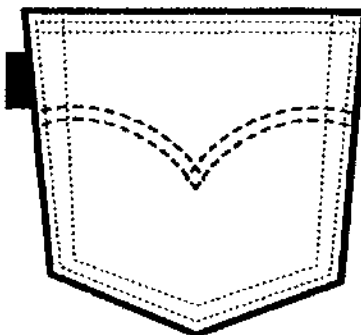

LEVI STRAUSS & CO. (DELAWARE CORPORATION)  
1155 BATTERY STREET  
SAN FRANCISCO, CA 94111

FOR: PANTS, JEANS, SHORTS, SHIRTS, T-SHIRTS, BLOUSES, SKIRTS AND JACKETS, IN CLASS 25 (U.S. CLS. 22 AND 39).

FIRST USE 9-1-1936; IN COMMERCE 9-1-1936.

OWNER OF U.S. REG. NOS. 1,041,846, 1,135,196, AND 1,139,254.

THE LINING AND SHADING SHOWN IN THE DRAWING ARE FEATURES OF THE MARK AND NOT INTENDED TO INDICATE COLOR.

THE MARK CONSISTS OF THE COMBINATION OF A DOUBLE ARCUATE AND TAB DESIGN SHOWN ON THE SHAPE OF A POCKET, AS INDICATED BY A SOLID LINE.

SER. NO. 78-144,339, FILED 7-16-2002.

ELLEN B. AWRICH, EXAMINING ATTORNEY

7096689



**THE UNITED STATES OF AMERICA**

**TO ALL TO WHOM THESE PRESENTS SHALL COME:**

**UNITED STATES DEPARTMENT OF COMMERCE**

**United States Patent and Trademark Office**

**April 06, 2006**

**THE ATTACHED U.S. TRADEMARK REGISTRATION 2,794,649 IS  
CERTIFIED TO BE A TRUE COPY WHICH IS IN FULL FORCE AND  
EFFECT WITH NOTATIONS OF ALL STATUTORY ACTIONS TAKEN  
THEREON AS DISCLOSED BY THE RECORDS OF THE UNITED STATES  
PATENT AND TRADEMARK OFFICE.**

**REGISTERED FOR A TERM OF 10 YEARS FROM *December 16, 2003***

**SAID RECORDS SHOW TITLE TO BE IN:**

***LEVI STRAUSS & CO.***

***A DELAWARE CORPORATION***

**By Authority of the  
Under Secretary of Commerce for Intellectual Property  
and Director of the United States Patent and Trademark Office**

*L. Edelen*

**L. EDELEN  
Certifying Officer**



**Int. Cl.: 25**

**Prior U.S. Cls.: 22 and 39**

**United States Patent and Trademark Office**

**Reg. No. 2,794,649**

**Registered Dec. 16, 2003**

**TRADEMARK  
PRINCIPAL REGISTER**



LEVI STRAUSS & CO. (DELAWARE CORPORATION)  
1155 BATTERY STREET  
SAN FRANCISCO, CA 94111

THE MARK CONSISTS OF A DOUBLE ARCUATE DESIGN.

FOR: PANTS, JEANS, SHORTS, SHIRTS, T-SHIRTS, BLOUSES, SKIRTS AND JACKETS, IN CLASS 25 (U.S. CLS. 22 AND 39).

SER. NO. 78-142,765, FILED 7-10-2002.

FIRST USE 0-0-1873; IN COMMERCE 0-0-1873.

GINNY ISAACSON, EXAMINING ATTORNEY

# State of California

## SECRETARY OF STATE

Trademark Reg. No. 88399      Class No. Int. 25      Renewal No. 15637  
**CERTIFICATE OF RENEWAL OF TRADEMARK**

*I, BILL JONES, Secretary of State of the State of California, hereby certify:*

That an application for renewal has been filed in this office for the TRADEMARK described below:

Name of Applicant: Levi Strauss & Co.  
Business Address: 1155 Battery Street San Francisco, CA 94111  
Date First Used in California: 1873  
Date First Used Anywhere: 1873  
Description of Trademark: Arc Design. Design of two concentric arcs placed in such a manner that they meet in the center  
Description of Goods on Which the Trademark is Used: Pants, shirts, and jackets  
Date of Registration: August 24, 1988  
Term of Registration Extends to and Includes: August 24, 2008

**IN WITNESS WHEREOF, I execute  
this certificate and affix the Great  
Seal of the State of California this  
6th day of July, 1998**



*Bill Jones*  
BILL JONES  
Secretary of State



# State of California

## Secretary of State

### RENEWAL OF TRADEMARK OR SERVICE MARK

Pursuant to Business and Professions Code Section 14250

(APPLICATION FOR RENEWAL MUST BE RECEIVED BY THE SECRETARY OF STATE WITHIN (BUT NOT BEFORE) THE SIX-MONTH PERIOD PRIOR TO THE DATE OF EXPIRATION OF THE CURRENT REGISTRATION TOGETHER WITH RENEWAL FEE.)

SEND THE SIGNED APPLICATION WITH ORIGINAL SIGNATURE(S) TO THE SECRETARY OF STATE, TRADEMARK UNIT, P.O. BOX 944225, SACRAMENTO, CA 94244-2250.

RENEWAL APPLICATION FOR:  TRADEMARK  SERVICE MARK

1. NAME OF APPLICANT:  
**LEVI STRAUSS & CO.**

2. STREET ADDRESS: (DO NOT GIVE P. O. BOX) (FOR SERVICE MARK, PROVIDE CALIFORNIA BUSINESS ADDRESS)  
**1155 Battery Street**

CITY: <b>San Francisco</b>	STATE: <b>CA</b>	ZIP CODE <b>94111</b>
-------------------------------	---------------------	--------------------------

3. BUSINESS STRUCTURE: (CHECK ONE)

<input type="checkbox"/> LIMITED PARTNERSHIP	<input type="checkbox"/> SOLE PROPRIETOR
<input type="checkbox"/> LIMITED LIABILITY COMPANY	<input type="checkbox"/> UNINCORPORATED ASSOCIATION
<input type="checkbox"/> GENERAL PARTNERSHIP	<input type="checkbox"/> HUSBAND AND WIFE, AS COMMUNITY PROPERTY
<input checked="" type="checkbox"/> CORPORATION (STATE OF INCORPORATION) <u>Delaware</u>	<input type="checkbox"/> OTHER (DESCRIBE) _____

4. IF PARTNERSHIP, LIST NAMES OF PARTNERS	5. NAMES OF MEMBER(S) OR MANAGER(S), IF APPLICANT IS A LIMITED LIABILITY COMPANY
---	--

6. NAME AND/OR DESCRIPTION OF TRADE/SERVICE MARK: **A device created by two concentric arcs placed on pockets in such a manner that they meet in the center thereof, usually applied by stitching. Arc DESIGN.**

7. TRADE/SERVICE MARK REGISTRATION NUMBER <b>088399</b>	8. DATE OF REGISTRATION <b>August 24, 1988</b>
--	---

THE MARK WAS ADOPTED, USED, AND CONTINUES TO BE USED WITHIN THE STATE OF CALIFORNIA BY THE APPLICANT IN THE FORM AND MANNER SPECIFIED IN THE PRESENT REGISTRATION.

9. NAME OF CORPORATION/PARTNERSHIP/LIMITED LIABILITY COMPANY (IF APPLICABLE)  
**LEVI STRAUSS & CO.**

THIS SPACE FOR FILING OFFICER USE

TRADE/SERVICE MARK

REG. NO. 88399

RENEWAL NO. 015637

SIGNATURE (IF PARTNER OR CORPORATE OFFICER, INCLUDE TITLE.) DATE

*[Signature]*

10. RETURN ACKNOWLEDGMENT TO: (TYPE OR PRINT)

NAME	[ Sarah R. Fuller ]
ADDRESS	[ Legal Strategies Group ]
	[ 5905 Christie Avenue ]
CITY	[ Emeryville, CA 94608-1925 ]
STATE	
ZIP CODE	

**FILED**  
In the office of the Secretary of State  
of the State of California

**JUL - 6 1998**

*[Signature]*  
**BILL JONES, Secretary of State**

ARC 10021B



Office of  
**March Fong Eu**  
Secretary of State  
SACRAMENTO

SEP 01 1988

As Secretary of State, it is my pleasure to notify you that the mark you submitted has been registered in this office.

Please be advised that Section 14220(f) of the Business and Professions Code specifies that a mark shall not be registered if it so resembles a mark or trade name already registered or used in this state by another and not abandoned, as to be likely, when applied to the goods or services of the applicant, to cause confusion or mistake or to deceive.

My office has conducted a search of California trademark and service mark registrations. Your mark does not appear to resemble any previous registration.

Please be advised, however, that there may be unregistered marks or California trade names used by corporations and partnerships, fictitious names, and names under which individuals conduct business which may resemble your registration. A check for such names is beyond the scope of the review of this office in registering marks.

Most sincerely,

*March Fong Eu*  
MARCH FONG EU



# State of California

OFFICE OF THE SECRETARY OF STATE



Trademark  
Reg. No. 088399

## CERTIFICATE OF REGISTRATION OF TRADEMARK

I, MARCH FONG EU, Secretary of State of the State of California, hereby certify:

That in accordance with the application filed in this office the TRADEMARK described below has been duly registered in this office on behalf of:

Name of Applicant LEVI STRAUSS & CO.

Business Address 1155 Battery Street  
San Francisco, CA 94111

Date First Used in California 1873

Date First Used Anywhere 1873

Description of Trademark A device created by two concentric arcs placed on pockets in such a manner that they meet in the center thereof, usually applied by stitching.

Class No. 39

Description of Goods on Which the Trademark is Used Pants, shirts and jackets

A copy, specimen, facsimile, counterpart or a reproduction of the mark is attached.

Date of Registration August 24, 1988

Term of Registration Extends to and Includes August 24, 1998

*IN WITNESS WHEREOF*, I execute this certificate and affix the Great Seal of the State of California this

24th day of August, 1988



*March Fong Eu*

Secretary of State



A COPY, SPECIMEN, FACSIMILE, COUNTERPART OR  
REPRODUCTION OF TRADEMARK REG. NO. 088399

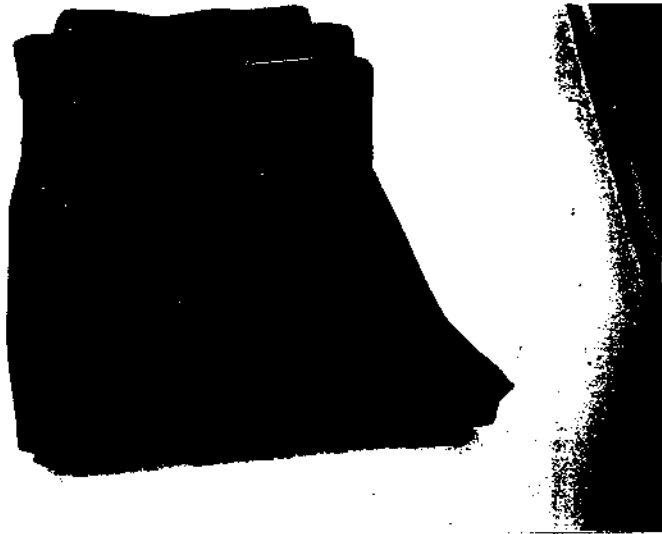





APPLICATION TO REGISTER A TRADEMARK  
IN THE STATE OF CALIFORNIA

TO: MARCH FONG EU  
Secretary of State  
923 12th Street, Suite 301  
Sacramento, California 95814  
(916) 445-9872

Trademark  
Reg. No. 088399  
Class No. 39

**FILED**  
in the office of the Secretary of State  
of the State of California  
AUG 24 1988  
*March Fong Eu*  
MARCH FONG EU  
SECRETARY OF STATE

Applicant requests registration of the trademark described below and submits the following information along with the registration fee of \$50.00:

1. Name of Applicant LEVI STRAUSS & CO.

CHECK ONE:  Sole Proprietor  Corporation  
 Limited Partnership  General Partnership  
 Unincorporated Association  
 Husband and Wife, as community property  
 Other (Describe) \_\_\_\_\_

2. Business Address, City, State 1155 Battery Street, San Francisco, CA 94111

3. State of Incorporation, if applicant is a corporation Delaware

4. Names of the general partners, if applicant is a partnership \_\_\_\_\_

5. Description of the Trademark. The trademark consists of the following:  
A device created by two concentric arcs placed on pockets in such a manner  
that they meet in the center thereof, usually applied by stitching.

6. The specific goods, products, or merchandise (stock-in-trade) which the applicant(s) sell(s) to the customers, and on which the trademark is used, are/is as follows:  
pants, shirts and jackets

7. The trademark has previously been used, and is now being used on said goods in the State of California as follows:

- On labels and tags affixed to the goods.
- On labels and tags affixed to containers of the goods.
- By printing it directly onto the goods.
- By printing it directly onto the containers for the goods.

8. Enclosed as specimens or facsimiles are:

- Five identical actual labels.
- Five identical actual tags.
- Five identical photographs of the goods/containers showing the trademark thereon.
- Five entire front panels of a paper container bearing the trademark.

9. The date the trademark was first used in California is 1873.

The date the trademark was first used anywhere is 1873.

The applicant is the owner of the mark and no other person has the right to use such mark in the State of California either in the identical form thereof or in such near resemblance thereto as might be calculated to deceive or to be mistaken therefor.

LEVI STRAUSS & CO.

Type name of corporation or partnership on above line (leave above line blank if sole proprietor)

BY

Tracy MacLeod  
Signature of applicant, partner, officer of corporation; if partner, so state and if officer, set forth title of office  
Tracy MacLeod, Assistant Secretary

VERIFICATION

Tracy MacLeod

declares under penalty of perjury under the laws of the State of California that the statements contained in the foregoing application are true of his/her own knowledge.

DATED: June 30, 1988

BY

Tracy MacLeod  
Signature of applicant, partner, officer of corporation; if partner, so state and if officer, set forth title of office

TM 88 399



## Exhibit C



Exhibit C